

BLAST GATE SIZES

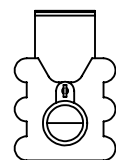

BG-2

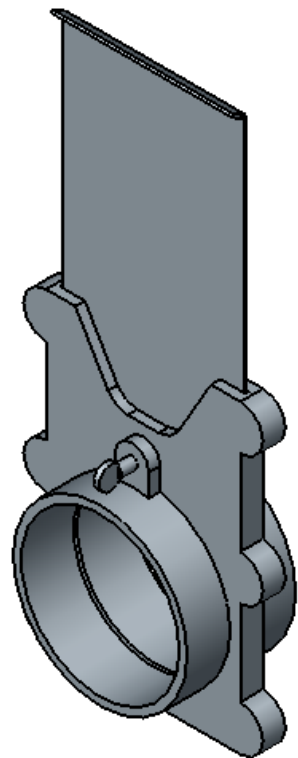
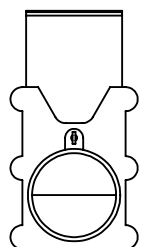

BG-4

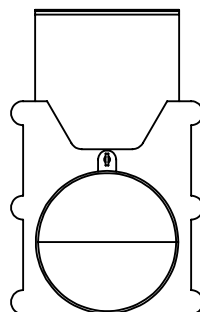

BG-6

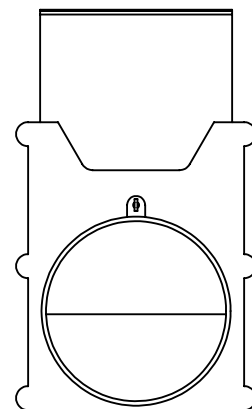

BG-8

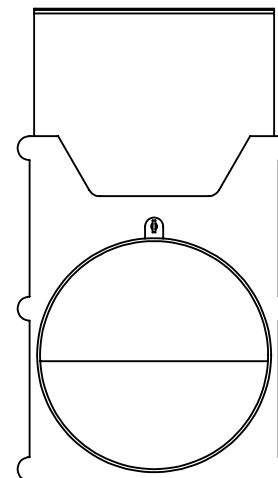

BG-10

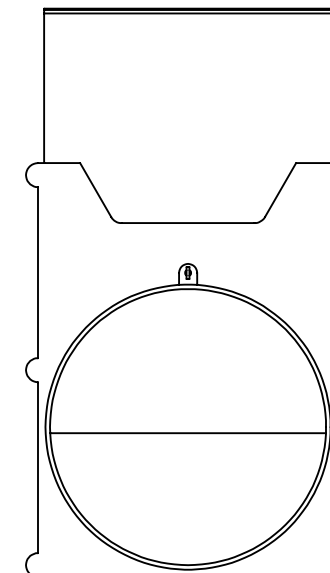

BG-12

BLAST/SLIDE GATE OPTIONS

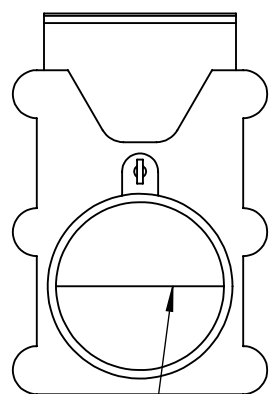

HALF SLIDE

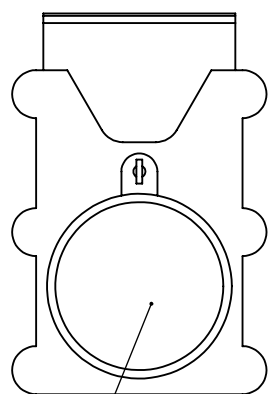

FULL SLIDE

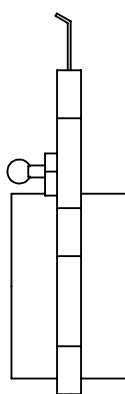

FULL BLAST GATE

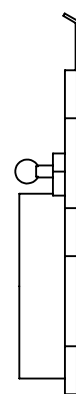

FACE MOUNTED BLAST GATE

AF1-BG-X-XX

OUTLET ϕ
 BG - Full Blast Gate
 BGFM - Face Mounted Blast Gate

OUTLET ϕ
 *2 - ϕ 2"
 4 - ϕ 4"
 6 - ϕ 6"
 8 - ϕ 8"
 10 - ϕ 10"
 12 - ϕ 12"

GATE OPTIONS
 "NIL" - Full Slide
 HS - Half Slide

* - does not fit inside of duct. Rivet duct to inside



Air Force 1 Blow Off Systems

609 Colby Drive, Waterloo
 Ontario, N2V 1A1, Canada
 phone: (519) 746-5035
 www.af1.com

DRAWN BY: CEW DATE: DD-JUN-08
 CHK BY: DATE:
 ENG. APPR: DATE:
 UNLESS OTHERWISE SPECIFIED:
 DIMENSIONS ARE IN INCHES
 TOLERANCES:
 FRACTIONAL \pm 1/8"
 ANGULAR MACH \pm .5 BEND \pm .01
 TWO PLACE DECIMAL \pm .01
 THREE PLACE DECIMAL \pm .001
 FOUR PLACE DECIMAL \pm .0005
 INTERPRET GEOMETRIC
 TOLERANCING PER: ASME Y14.5M-1994
 PROPRIETARY AND CONFIDENTIAL
 THE INFORMATION CONTAINED IN THIS DRAWING IS
 THE SOLE PROPERTY OF AIR FORCE 1 BLOW OFF
 SYSTEMS. ANY REPRODUCTION IN WHOLE OR IN
 PART WITHOUT THE WRITTEN PERMISSION OF AIR
 FORCE 1 BLOW OFF SYSTEMS IS PROHIBITED.

No.	REVISION	DATE	BY

CAD FILE NAME: **BLAST GATES** SIZE: **B SIZE**

DRAWING TITLE: BLAST GATES	
CUSTOMER: AF1	
SCALE: 1:8	REV: 0
BLAST GATES	
SHEET 1 OF 1	